

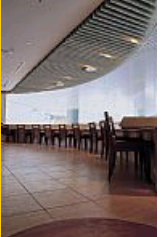

# PQRY-P400YSHM-A

WR2 Series 16hp Water Cooled Condensing Unit

R410A Heat Recovery



## Simultaneous Heating and Cooling with Double Heat Recovery

The WR2 Series has double heat recovery potential, making this system very economical. Not only does it produce heat recovery from the indoor units on the same 2-pipe refrigerant circuit, it also produces heat recovery via the water circuit between heat source units. This series has all the benefits of the R2 Series with water cooled condensing units, using a single inverter compressor.



Pictures not to scale

## Product Details

PQRY-P400YSHM-A	
Capacity (kW):	
Heating (Nominal)	50.0
Cooling (Nominal)	45.0
Power Input (kW) Heating (Nominal)	8.65
Power Input (kW) Cooling (Nominal)	8.32
Max No. of Connectable Indoor Units	40
Noise (dBA)	50
Width - mm	880 + 880
Depth - mm	550
Height - mm	1160
Weight - kg	186 + 186
Electrical Supply	380-415v, 50Hz
Phase	3
Mains Cable No. Cores	4 + earth
Starting Current (A)	8
Running Current (A) - Heating	13.3
Running Current (A) - Cooling	12.8

### Piping Restrictions

Total Piping Length (m)	750
Furthest Piping Length (m)	165
Between Outdoor and BC Controller (Master) - Length (m)	110
Length Between Indoor and BC Controller (Master / Slave) - Length (m)	60
Between Indoor and Outdoor Units - Height (m)	50
Between Indoor and Indoor Units - Height (m)	15
Between Indoor and BC Controller (Master/Slave) - Height (m)	15

## Dimensions

PQRY-P400YSHM-A

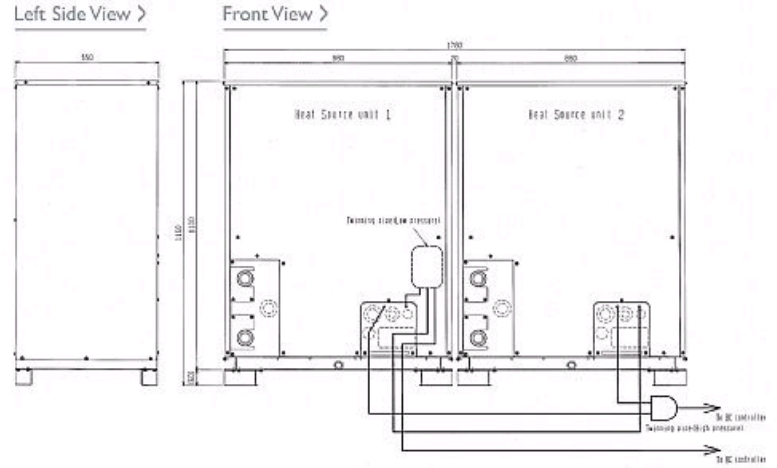

Telephone: 01707 282880

Email: [air.conditioning@meuk.mee.com](mailto:air.conditioning@meuk.mee.com) Website: <http://www.mitsubishielectric.co.uk/aircon>

Mitsubishi Electric reserves the right to make any variation in technical specification to the equipment described, or to withdraw or replace products without prior notification or public announcement.

Tel:  
Fax:

